



■ Features:

- Miniature size
- Available on tape and reel for automatic insertion
- Lead free part available

■ Applications:

- DC to DC converters for portable equipment , camcorder , LCD television set , digital camera , P.D.A., notebook

■ Parts code:

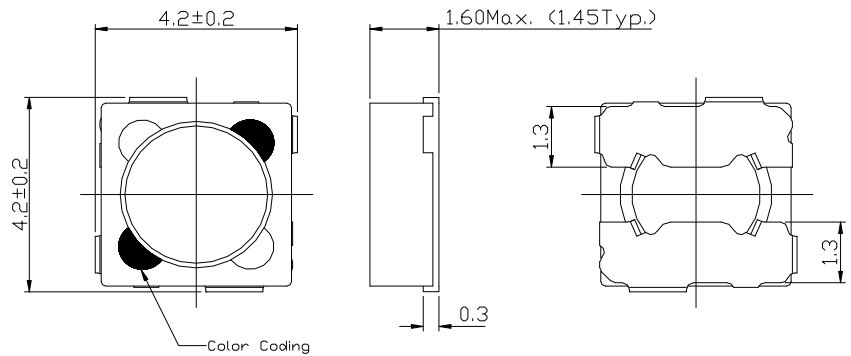
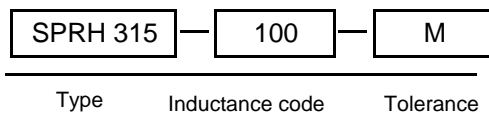

■ Specifications

Inductance			SPRH 315		
			DCR	IDC	I _{rms}
TYPE		uH	(Ω)	35% (A)	25 °C
SPRH 315-R50	M/N	0.5	0.035	3.90	2.50
SPRH 315-1R0	M/N	1.0	0.040	3.00	2.40
SPRH 315-1R2	M/N	1.2	0.043	2.80	2.34
SPRH 315-1R5	M/N	1.5	0.050	2.60	2.30
SPRH 315-1R8	M/N	1.8	0.055	2.30	2.10
SPRH 315-2R2	M/N	2.2	0.071	2.20	2.00
SPRH 315-2R7	M/N	2.7	0.078	2.00	1.60
SPRH 315-3R3	M/N	3.3	0.087	2.00	1.60
SPRH 315-3R9	M/N	3.9	0.100	1.80	1.50
SPRH 315-4R7	M/N	4.7	0.137	1.60	1.40
SPRH 315-5R6	M/N	5.6	0.147	1.46	1.20
SPRH 315-6R8	M/N	6.8	0.170	1.40	1.15
SPRH 315-8R2	M/N	8.2	0.195	1.28	1.10
SPRH 315-100	M	10	0.228	1.16	1.02
SPRH 315-120	M	12	0.275	1.08	0.90
SPRH 315-150	M	15	0.340	0.86	0.72

■ Notes 1. Test Freq. : 1KHz / 1.0V

2. PACKAGING: 1000Pcs/Reel

3. Tolerance: M=±20% , N=±30%

4. Operating temperature range: -25~+105°C